

# TETRIS<sup>®</sup> 2500

High Impedance Active Probe

Instruction Manual



**Copyright © 2015 PMK GmbH** All rights reserved.

Information in this publication supersedes that in all previously published material.  
Specifications are subject to change without notice.

## **Manufacturer**

---

PMK Mess- und Kommunikationstechnik GmbH  
Königsteiner Str. 98  
65812 Bad Soden, Germany

Internet: [www.pmk.de](http://www.pmk.de)

Tel: +49 (0) 6196 5927 - 930

E-Mail: [sales@pmk.de](mailto:sales@pmk.de)

Fax: +49 (0) 6196 5927 - 939

## **Warranty**

---

PMK GmbH warrants this oscilloscope accessory for normal use and operation within specifications for a period of two (2) years from date of shipment and will repair or replace any defective product which was not damaged by negligence, misuse, improper installation, accident or unauthorized repair or modification by the buyer. This warranty is applicable only to defects due to material or workmanship. PMK GmbH disclaim any other implied warranties of merchantability or fitness for a particular purpose. PMK GmbH will not be liable for any indirect, special, incidental, or consequential damages (including damages for loss of profits, loss of business, loss of use or data, interruption of business and the like), even if PMK GmbH has been advised of the possibility of such damages arising from any defect or error in this manual or product.



(EC conformity marking)

The manufacturer declares, that this product is designed and manufactured in accordance with the requirements of the specified Directives and Standards as listed below. The product carries the CE mark.

**EU Directives covered by this declaration:**

2004/108/EC Electromagnetic Compatibility Directive  
2006/95/EC Low Voltage Equipment Directive  
2002/96/EC Waste Electrical and Electronic Equipment  
2002/95/EC Restriction of use of certain Hazardous Substances and its revised version 2011/65/EU

**The basis on which conformity is being declared:**

EN61010-1:2010 Safety requirements for electrical equipment for measurement, control and laboratory use, general equipment requirements

EN61010-031:2002 + A1:2008  
Safety requirements for hand-held probe assemblies for electrical measurement and test

EN61326-1:2006 Electrical equipment for measurement, control and laboratory use – EMC requirements. Basic Immunity - static discharge per EN61000-4-2

RoHS and WEEE Statements and Confirmations issued by our vendors that no hazardous or restricted substances are used to manufacture components, parts and subassemblies for our products.

**TETRIS Power Supplies**

Models PS-01 and PS-01-INT (International version with exchangeable mains adapters) are manufactured in Germany by Friwo Gerätebau GmbH. The power supplies are not included in the scope of this declaration of conformity. Upon request we are able to provide full information about conformity and certifications of the power supplies made by Friwo and supplied with our TETRIS probes.

**WEEE/ RoHS Directives**

---



(EC conformity marking)



Your help and efforts are required to protect and keep clean our environment. Therefore return this electronic product at the end of its life either to the Service Department of PMK Mess- und Kommunikationstechnik GmbH or take care of separate WEEE collection and professional WEEE treatment yourself. Do not dispose as unsorted municipal waste.

\* EC Directives:

WEEE Directive 2002/96/EC - Waste Electrical and Electronic Equipment  
RoHS Directive 2002/95/EC - Restriction of the use of certain Hazardous Substances in Electrical and Electronic Equipment

The following symbols may appear on the product or in this instruction manual:



Caution, risk of danger. Refer to manual.



Caution, risk of electric shock.



Earth (ground) TERMINAL.

To avoid personal injury and to prevent fire or damage to this product or products connected to it, review and comply with the following safety precautions. Be aware that if you use this probe assembly in a manner not specified the protection this product provides may be impaired.

**Only qualified personnel should use this probe assembly.**

**Use only grounded instruments.**

Do not connect the probe ground lead to a potential other than earth ground. Always make sure the probe and the measurement instrument are grounded properly.

**Connect and disconnect properly.**

Connect the probe output to the measurement instrument and connect the ground lead to earth ground before connecting the probe to the circuit under test. Disconnect the probe input and the probe ground lead from the circuit under test before disconnecting the probe from the measurement instrument.

**Observe probe ratings.**

Do not apply any electrical potential to the probe input which exceeds the maximum ratings of the probe.

**Keep away from live circuits.**

Avoid open circuitry. Do not touch connections or components when power is present.

**Do not operate with suspected failures.**

Refer to qualified service personnel.

**Indoor use only.**

Do not operate in wet/damp environment. Keep product surfaces dry and clean.

**Do not operate the product in an explosive atmosphere.**

PMK presents a unique Inline Probing System – the TETRIS<sup>®</sup> active probe which can contact adjacent square pins in 2.54 mm pitch simultaneously. The probe's housing is T-shaped so that many probes can be positioned next to each other in a never ending chain.

Like this a number of measurements can be performed at the same time. The TETRIS<sup>®</sup> is system-independent and its standard SMA connector can be plugged onto any measuring instrument with a 50  $\Omega$  input.

With an input resistance of 1 M $\Omega$  and an input capacitance of 0.9 pF the TETRIS<sup>®</sup> probe is suitable for measurements in all frequency ranges.

Compared to passive probes the TETRIS<sup>®</sup> active probe offers a high input impedance into the GHz-range. Passive probes with their relative high input capacitance load the signal source already at frequencies above 100 kHz.

That's why the TETRIS<sup>®</sup> active probe with its high input resistance and its low input capacitance is the ideal probe for most of your daily measurements.

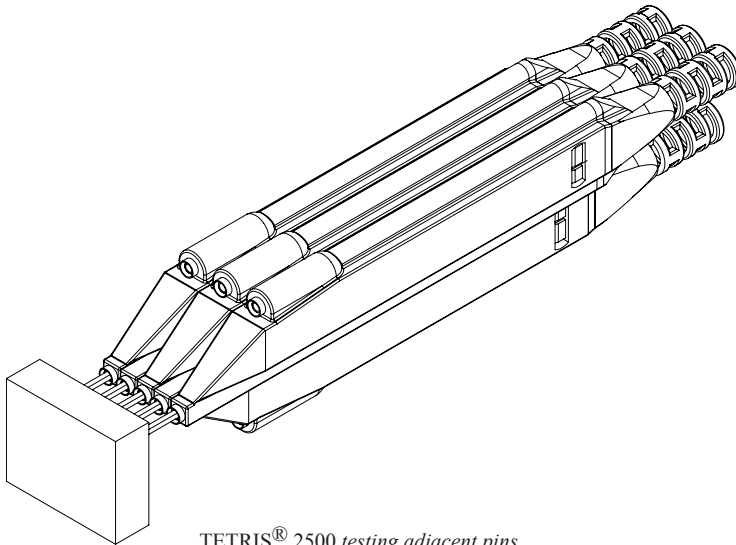

*TETRIS<sup>®</sup> 2500 testing adjacent pins  
in 2.54 mm Pitch*

When using this active probe device make sure the measuring instrument is set to 50 Ω input coupling and the probe is connected to the power supply.

**Handling**



Note that the probe cable is a sensitive part of the probe. Do not damage through excessive bending or pulling. Avoid mechanical shock to this product in general to guarantee accurate performance and protection.

**Power Supply**

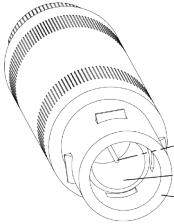

	Double Voltage	Single Voltage
Inner Connector	+12 V	24 V
Inner Shielding	-12 V	0 V
Outer Shielding	Earth-Ground	Open (floating)

Required Current	150mA
Connector Type	Triaxial Lemosa Connector



*Please note, that any noise of the supply voltage influences the noise of the signal in general.*

**Maintenance**

**Cleaning**

To clean the exterior of the probe use a soft cloth moistened with either distilled water or isopropyl alcohol. Before use allow the probe to dry completely.

Specifications that are not defined to be guaranteed are typical and published as general information to the user. The instrument should have warmed-up for at least 20 minutes and the environmental conditions should not exceed the probe's specified limits.

**Electrical Specifications**

Attenuation Ratio	10:1	± 0.5 % at DC
Dynamic Measuring Range	± 8 V	
System Bandwidth <sup>(1)</sup>	2 GHz	(-3 dB)
Bandwidth (Probe only)	2.5 GHz	
Maximum Rated Input Voltage	20 V	

**Max. Input Voltage and Dynamic Measuring Range**

The TETRIS® active probe is protected against electro-static-discharge voltage (ESD). However, applying input-voltages outside the specified limits can result in destruction of the probe's amplifier.



*The maximum amplitude of the applied signal may not exceed the limits of the graph below, to avoid input linearity errors and damage to the probe*



*The maximum amplitude of the applied signal may not exceed the limits of the graph below, to avoid damage to the probe.*

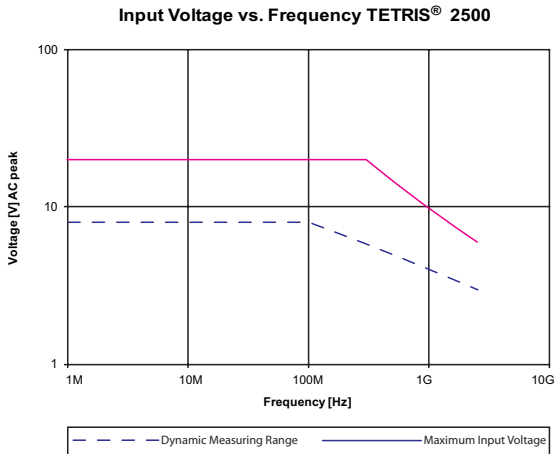

*To avoid input linearity errors and damage to the probe feel free to contact our customer support under sales@pmk.de for questions regarding the maximum input range or dynamic measuring range.*

(1) connected to oscilloscope >2.0 GHz



**Electrical Characteristics**

Input Resistance (System)	> 1 M $\Omega$
Input Capacitance (System)	0.9 pF
Oscilloscope Input Coupling	50 $\Omega$ AC / DC

**Input Impedance**

*Note that the input impedance of the probe decreases as the frequency of the applied signal increases. For further information on the matter contact our support under [sales@pmk.de](mailto:sales@pmk.de).*

**Mechanical Characteristics**

Weight (probe only)	96 g
Cable Length	1.3 m

**Environmental specifications**

Altitude	operating	up to 2000 m
	non-operating	up to 15000 m
Temperature Range	operating	0° C to +45° C
	non-operating	-40° C to +71° C
Maximum Relative Humidity	operating	80 % relative humidity for temperatures up to +31° C, decreasing linearly to 40 % at +45° C

890-700-108  
Set 10 PCB Adapters  
890-700-258  
Set 25 PCB Adapters

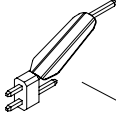

890-400-800  
Z - Ground



018-291-103  
Ground Blade

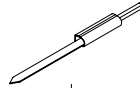

018-291-105  
Ground Leaf

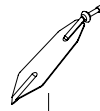

890-100-150  
10 self-adhesive  
Cu Pads  
( 2 x 2 cm )

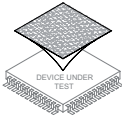

890-800-001  
Set 5 Spring  
Tips



890-800-000  
Set 5 Solid  
Tips



890-500-801  
L - In Adapter

890-502-130  
QFP IC-Clip 13 mm long  
down to 0.5 mm pitch  
( 1 pair, yellow/green )

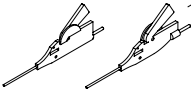

890-502-000  
QFP IC-Clip short  
down to 0.5 mm pitch  
( 1 pair, yellow/green )

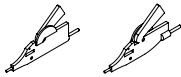

P25-2  
Pico hook™  
red

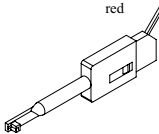

P25-0  
Pico hook™  
black

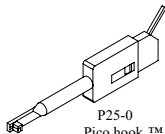

890-720-800  
Y-Lead Adapter  
to 0.8 mm sockets 10 cm

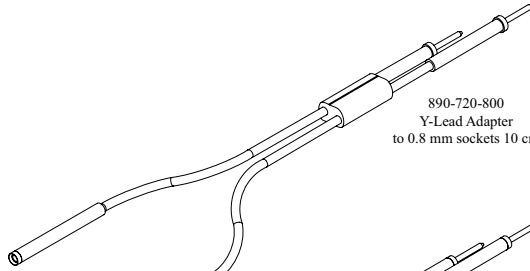

890-720-816  
Y-Lead Adapter  
to open Leads 6 cm

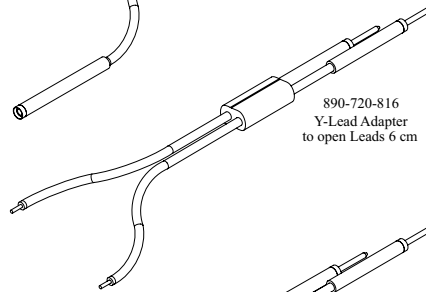

890-720-813  
Y-Lead Adapter  
to open Leads 3 cm

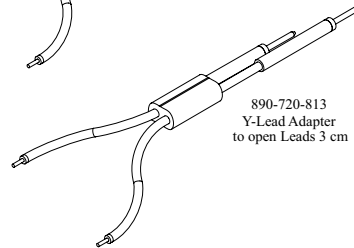

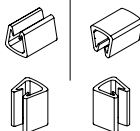
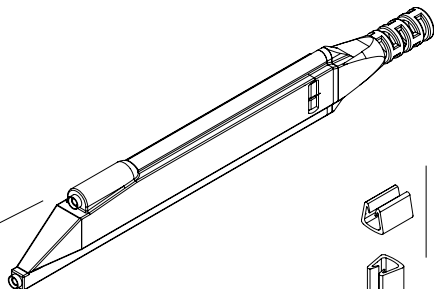

890-020-916  
Marker Bands  
4 Colors

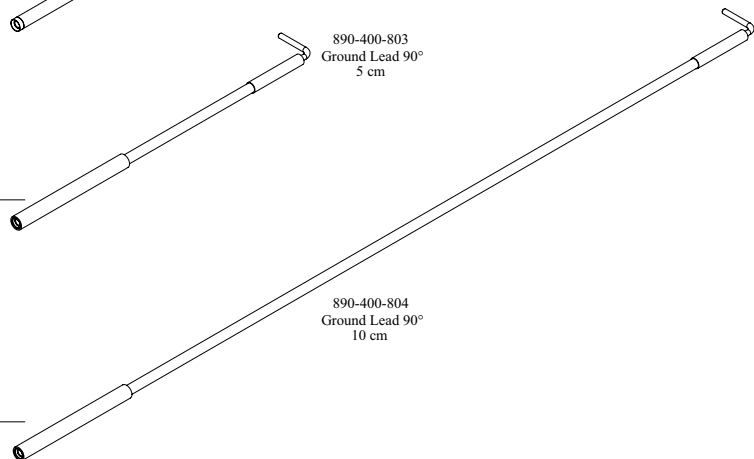
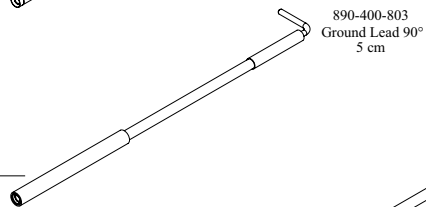
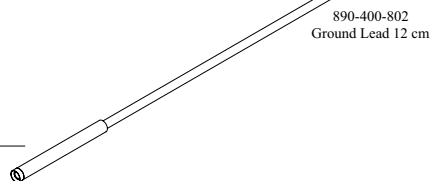
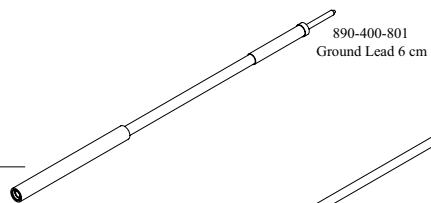

The following items are included in the scope of delivery. Please check the delivery for completeness. If any item is missing, send a message to our service department and we will send you this item immediately.

<b>Item</b>	<b>Qty</b>
Ground Blade	1
Ground Lead 6 cm	1
Ground Lead 12 cm	1
Ground Lead 90° 5 cm	1
Ground Lead 90° 10 cm	1
Ground Leaf	1
Instruction Manual	1
L-In Adapter	1
Marker Bands 4 colors	1
PCB Adapter	1
Picohook™ black	1
Picohook™ red	1
Power Supply	1
Probe	1
self adhesive Cu Pad (2 x 2 cm)	2
Solid Tip	1
Spring Tip	1
Y-Lead Adapter to 0.8 mm sockets	1
Z-Ground	1



*Use ground lead only for connections to earth ground.*



*The accessories provided with the probe have been safety tested. Do not use any other accessories than those “originally” provided.*